

Inductive sensor

NBN40-U4-Z2-V1

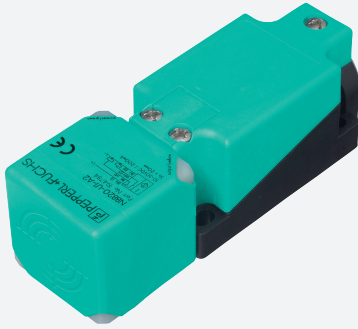

- Sensor head bidirectional and rotatable
- 40 mm non-flush
- 2-wire DC
- 2 LEDs indicator for 360° visibility



Dimensions

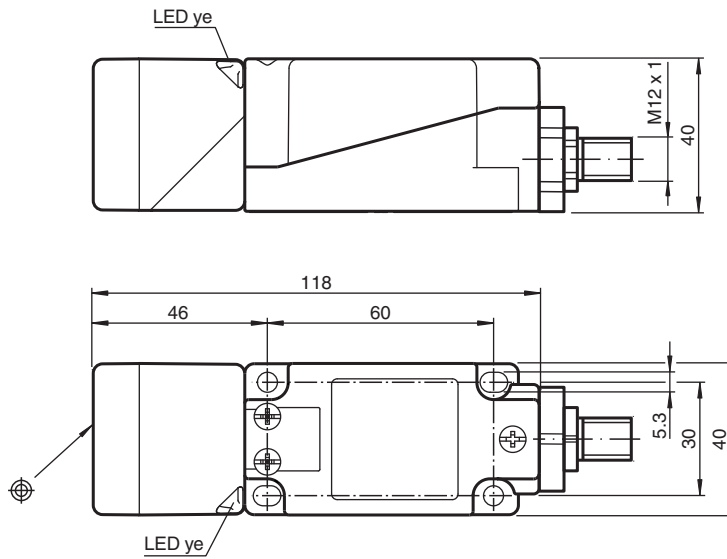

Technical Data

General specifications

Switching function		Normally open/closed (NO/NC)
Output type		Two-wire
Rated operating distance	s_n	40 mm
Installation		non-flush
Output polarity		DC
Assured operating distance	s_a	0 ... 32.4 mm
Actual operating distance	s_r	36 ... 44 mm typ. 40 mm
Reduction factor r_{Al}		0.3
Reduction factor r_{Cu}		0.3

Release date: 2022-06-22 Date of issue: 2022-06-22 Filename: 203110_eng.pdf

Refer to "General Notes Relating to Pepperl+Fuchs Product Information".

Pepperl+Fuchs Group
www.pepperl-fuchs.com

USA: +1 330 486 0001
fa-info@us.pepperl-fuchs.com

Germany: +49 621 776 1111
fa-info@de.pepperl-fuchs.com

Singapore: +65 6779 9091
fa-info@sg.pepperl-fuchs.com

PEPPERL+FUCHS

Technical Data

Reduction factor r_{304}		0.7
Output type		2-wire
Nominal ratings		
Operating voltage	U_B	5 ... 60 V DC
Switching frequency	f	0 ... 100 Hz
Hysteresis	H	typ. 5 %
Reverse polarity protection		reverse polarity tolerant
Short-circuit protection		pulsing
Voltage drop	U_d	≤ 5 V
Voltage drop at I_L		
Voltage drop $I_L = 100$ mA, switching element on	U_d	... 5 V
Operating current	I_L	2 ... 200 mA
Off-state current	I_r	0 ... 0.5 mA
Switching state indicator		2 LED, yellow
Functional safety related parameters		
MTTF _d		1170 a
Mission Time (T_M)		20 a
Diagnostic Coverage (DC)		0 %
Compliance with standards and directives		
Standard conformity		
Standards		EN 60947-5-2:2007 EN 60947-5-2/A1:2012 IEC 60947-5-2:2007 IEC 60947-5-2 AMD 1:2012
Approvals and certificates		
UL approval		cULus Listed, General Purpose
CCC approval		Certified by China Compulsory Certification (CCC)
Ambient conditions		
Ambient temperature		-25 ... 85 °C (-13 ... 185 °F)
Mechanical specifications		
Connection type		Connector plug M12 x 1 , 4-pin
Housing material		PA/metal with epoxy powder coating
Sensing face		PA
Housing base		metal
Degree of protection		IP68 / IP69K
Mass		225 g
Note		Tightening torque: 1.8 Nm (housing)

Connection

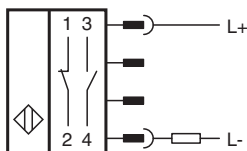





Connection Assignment



Wire colors in accordance with EN 60947-5-2

1	BN	(brown)
2	WH	(white)
3	BU	(blue)
4	BK	(black)

Accessories

	V1-G-2M-PUR	Female cordset single-ended M12 straight A-coded, 4-pin, PUR cable grey
	V1-W-2M-PUR	Female cordset single-ended M12 angled A-coded, 4-pin, PUR cable grey
	MHW 01	Modular mounting bracket
	MH 04-2681F	Mounting aid for VariKont, +U1+ and +U9*

Release date: 2022-06-22 Date of issue: 2022-06-22 Filename: 203110_eng.pdf